



Power Pruner™

Operator's Manual

MODEL: **PPT-265**
 PPT-265H
 PPT-265S

WARNING **DANGER**



The muffler or catalytic muffler and surrounding cover may become extremely hot.

Always keep clear of exhaust and muffler area, otherwise serious personal injury may occur.

WARNING

The engine exhaust from this product contains chemicals known to the State of California to cause cancer, birth defects or other reproductive harm.



WARNING

Read rules for safe operation and instructions carefully. ECHO provides an Operator's Manual and a Safety Manual. Both must be read and understood for proper and safe operation.

INTRODUCTION

Welcome to the ECHO family. This ECHO product was designed and manufactured to provide long life and on-the-job dependability. Read and understand this manual and the SAFETY MANUAL you found in the same package. You will find both easy to use and full of helpful operating tips and SAFETY messages.

THE OPERATOR'S MANUAL

Read and understand this manual before operation. Keep it in a safe place for future reference. It contains specifications and information for operation, starting, stopping, maintenance, storage, and assembly specific to this product.

THE SAFETY MANUAL

Read and understand this manual before operation. Keep it in a safe place for future reference. It explains possible hazards involved with the use of Power Pruner™ and what measures you should take to make their use safer.

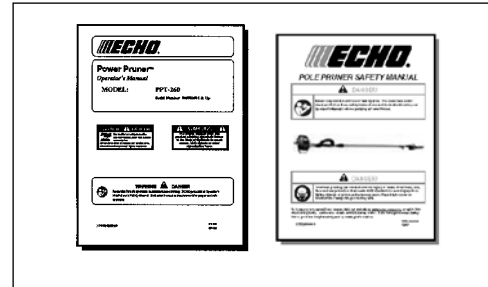

TABLE OF CONTENTS

Introduction.....	2		
- The Operator's Manual	2		
- The Safety Manual.....	2		
Safety	3		
- Manual Safety Symbols and Important Information	3		
- International Symbols	3		
- Personal Condition and Safety Equipment	4		
- Kickback	6		
- Equipment	7		
Emission Control	8		
Description.....	8		
Contents	12		
Assembly.....	12		
- Handle Shaft/Drive Shaft (PPT-265)	12		
- Handle Shaft/Power Head.....	13		
- Throttle Linkage and Ignition Leads.....	14		
- Cutting Attachment to Drive Shaft Installation	15		
- Saw Chain Tension Adjustment	16		
Operation.....	17		
- Fuel	17		
- Lubricating the Guide Bar and Saw Chain	19		
- Adjusting Automatic Oiler.....	19		
- Starting Cold Engine.....	20		
- Starting Warm Engine.....	21		
- Stopping Engine.....	22		
- Pruning Techniques.....	22		
		Maintenance	23
		- Skill Levels	23
		- Maintenance Intervals.....	23
		- Air Filter.....	24
		- Fuel Filter.....	24
		- Spark Plug.....	25
		- Cooling System Cleaning	25
		- Exhaust System.....	26
		- Carburetor Adjustment.....	28
		- High Altitude Operation	28
		- Guide Bar and Saw Chain Replacement.....	29
		- Filing Saw Chain.....	32
		Troubleshooting	33
		Storage	34
		Specifications	35
		Warranty Statements	36
		Servicing Information	40
		- Parts.....	40
		- Service.....	40
		- ECHO Consumer Product Support	40
		- Warranty Card.....	40
		- Additional or Replacement Manuals	40

Specifications, descriptions and illustrative material in this literature are as accurate as known at the time of publication, but are subject to change without notice. Illustrations may include optional equipment and accessories, and may not include all standard equipment.

SAFETY MANUAL SAFETY SYMBOLS AND IMPORTANT INFORMATION

Throughout this manual and on the product itself, you will find safety alerts and helpful, informational messages preceded by symbols or key words. The following is an explanation of those symbols and key words and what they mean to you.

DANGER

The safety alert symbol accompanied by the word “DANGER” calls attention to an act or condition which **WILL** lead to serious personal injury or death if not avoided.

WARNING

The safety alert symbol accompanied by the word “WARNING” calls attention to an act or condition which **CAN** lead to serious personal injury or death if not avoided.

CAUTION

The safety alert symbol accompanied by the word “CAUTION” calls attention to an act or condition which may lead to minor or moderate personal injury if not avoided.



CIRCLE AND SLASH SYMBOL

This symbol means the specific action shown is prohibited. Ignoring these prohibitions can result in serious or fatal injury.



NOTE











This enclosed message provides tips for use, care and maintenance of the unit.

IMPORTANT

The enclosed message provides information necessary for the protection of the unit.

INTERNATIONAL SYMBOLS

Symbol form/shape	Symbol description/application	Symbol form/shape	Symbol description/application
	Read and understand Operator's Manual.		Fuel and oil mixture
	Wear eyes, ears and head protection		Finger Severing
	Hot Surface		Wear hand protection. Use two handed.
	Safety/Alert		DO NOT smoke near fuel.
	Avoid all power lines. This unit is not insulated against electrical current.		Do not operate closer than 15 M (50 ft.) from electrical hazards.
	Keep bystanders at least 15 meters (50 feet) away.		Plan retreat path from falling objects.

Symbol form/shape	Symbol description/application	Symbol form/shape	Symbol description/application
	DO NOT allow flames or sparks near fuel.		Wear slip resistant foot wear.
	Emergency stop		Ignition ON/OFF
	Chain lubrication		Primer bulb
	Carburetor adjustment - Low speed mixture		Carburetor adjustment - High speed mixture
	Carburetor adjustment - Idle speed		
	Choke Control "Cold Start" Position (Choke Closed)		Choke Control "Run" Position (Choke Open)

PERSONAL CONDITION AND SAFETY EQUIPMENT



WARNING

Power Pruner™ users risk injury to themselves and others if the Power Pruner™ is used improperly and or safety precautions are not followed. Proper clothing and safety gear must be worn when operating a Power Pruner™.

Physical Condition

Your judgment and physical dexterity may not be good:

- if you are tired or sick,
- if you are taking medication,
- if you have taken alcohol or drugs.

Operate unit only if you are physically and mentally well.

Eye Protection

Wear eye protection that meets ANSI Z87.1 or CE requirements whenever you operate the unit

Face and Head Protection

When trimming overhead, always wear head protection meeting ANSI Z89.1 or CE requirements with a full face shield. Head protection with full face shield will help protect you from falling branches and debris.

Hand Protection

Wear no-slip, heavy duty work gloves to improve your grip on the unit handles. Gloves also reduce the transmission of machine vibration to your hands.

Hearing Protection

ECHO recommends wearing hearing protection whenever unit is used.

Proper Clothing

Wear snug fitting, durable clothing;

- Pants should have long legs, shirts with long sleeves.
- DO NOT WEAR SHORTS,
- DO NOT WEAR TIES, SCARVES, JEWELRY, or clothing with loose or hanging items that could become entangled in moving parts or surrounding growth.

Wear sturdy work shoes with nonskid soles;

- DO NOT WEAR OPEN TOED SHOES,
- DO NOT OPERATE UNIT BAREFOOTED.

Wear no-slip, heavy duty work gloves.

Keep long hair away from engine and air intake. Retain hair with cap or net.

Hot Humid Weather

Heavy protective clothing can increase operator fatigue which may lead to heat stroke. Schedule heavy work for early morning or late afternoon hours when temperatures are cooler.



WARNING

The ignition components of this machine generate an electromagnetic field during operation which may interfere with some pacemakers. To reduce the risk of serious or fatal injury, persons with pacemakers should consult with their physician and the pacemaker manufacturer before operating this machine. In the absence of such information, ECHO does not recommend the use of ECHO products by anyone who has a pacemaker.

Vibration and Cold

It is believed that a condition called Raynaud's Phenomenon, which affects the fingers of certain individuals may be brought about by exposure to vibration and cold. Exposure to vibration and cold may cause tingling and burning sensations followed by loss of color and numbness in the fingers. The following precautions are strongly recommended because the minimum exposure which might trigger the ailment is unknown.

- Keep your body warm, especially the head, neck, feet, ankles, hands and wrists.
- Maintain good blood circulation by performing vigorous arm exercises during frequent work breaks and also by not smoking.
- Limit the hours of operation. Try to fill each day with jobs where operating the unit or other hand-held power equipment is not required.
- If you experience discomfort, redness, and swelling of the fingers followed by whitening and loss of feeling, consult your physician before further exposing yourself to cold and vibration.

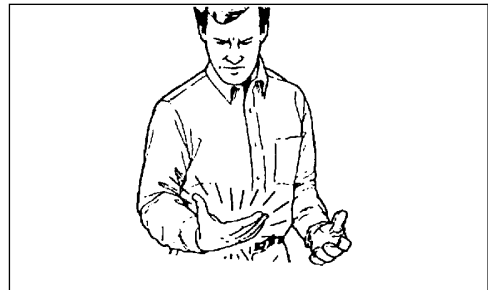

Repetitive Stress Injuries

It is believed that overusing the muscles and tendons of the fingers, hands, arms and shoulders may cause soreness, swelling, numbness, weakness and extreme pain in those areas. Certain repetitive hand activities may put you at a high risk for developing a Repetitive Stress Injury (RSI). An extreme RSI condition is Carpal Tunnel Syndrome (CTS), which could occur when your wrist swells and squeezes a vital nerve that runs through the area. Some believe that prolonged exposure to vibration may contribute to CTS. CTS can cause severe pain for months or even years.

To reduce the risk of RSI/CTS, do the following:

- Avoid using your wrist in a bent, extended or twisted position. Instead try to maintain a straight wrist position. Also, when grasping, use your whole hand, not just the thumb and index finger.
- Take periodic breaks to minimize repetition and rest your hands.
- Reduce the speed and force with which you do the repetitive movement.
- Do exercises to strengthen the hand and arm muscles.
- Immediately stop using all power equipment and consult a doctor if you feel tingling, numbness or pain in the fingers, hands, wrists or arms. The sooner RSI/CTS is diagnosed, the more likely permanent nerve and muscle damage can be prevented.

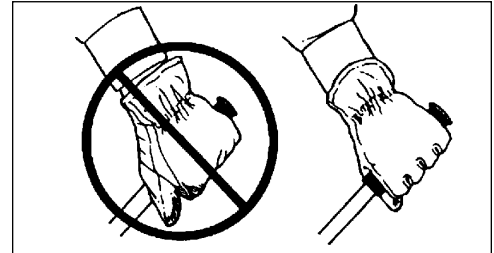

DANGER

All over head electrical conductors and communications wires can have electricity flow with high voltages. This unit is not insulated against electrical current. Never touch wires directly or indirectly when pruning, otherwise serious injury or death may result.



WARNING

Do not operate this product indoors or in inadequately ventilated areas. Engine exhaust contains poisonous emissions and can cause serious injury or death.

Read the Manuals

- Provide all operators of this equipment with the Operator's Manual, and instructions for safe operation.

Clear the Work Area

- Spectators and fellow workers must be warned, and children and animals prevented from coming nearer than 15 m (50 ft.) while the unit is in use.

Use Proper Clothing & Equipment

- Always wear head protection with full face shield to help protect against falling branches and debris.

Keep A Firm Grip

- Grip Power Pruner™ with both hands with thumbs and fingers encircling the handle, and shaft tube.

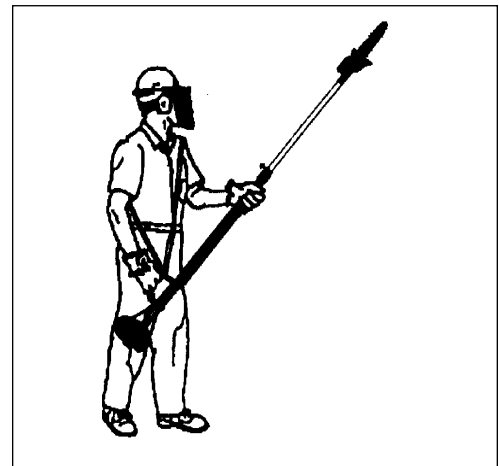

Keep A Solid Stance

- Maintain footing and balance at all times. Do not stand on slippery, uneven or unstable surfaces. Do not work in odd positions or on ladders. Do not overreach.
- Operate the Power Pruner™ only from the ground or out of an approved bucket lift.
- Always evaluate the branches to be pruned for hazards such as loose dead branches which may fall and strike the operator or helpers. Remove hazards before pruning.
- Plan retreat path from falling objects.
- Cut branches bounce when striking ground.
- Check that shoulder harness is adjusted for safe, comfortable operation. See picture at right for proper adjustment.
- Turn the Power Pruner™ off when moving from tree to tree.
- Avoid any contact with saw chain.

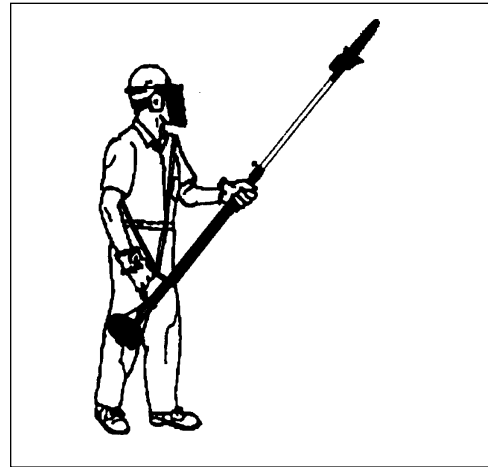
**Avoid Hot Surfaces**

- Keep exhaust area clear of flammable debris. Avoid contact during and immediately after operation.

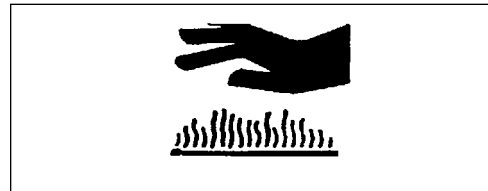
**KICKBACK****WARNING**

Kickback can lead to dangerous loss of control of the Power Pruner™ and result in serious injury to the operator or any one standing close by. Hold the Power Pruner™ firmly with both hands with thumbs and fingers encircling the front and rear handles. Be aware of the down and outward path the pruner will take after the cut is made.

Kickback may occur when the moving saw chain at the nose or tip of the guide bar touches an object, or when the wood closes in and pinches the saw chain in the cut. In some cases this may cause a lightning-fast reverse action, kicking the guide bar and saw chain up and back or down and back towards the operator. Either of these reactions may cause the operator to lose control of the Power Pruner™ which could result in serious personal injury.

With a basic understanding of kickback, you can reduce or eliminate the element of surprise which contributes to accidents.

Avoid contact of the guide bar tip with any object while the saw chain is moving.

Cut only wood. Avoid striking concrete, metal, wire, or other obstructions which could cause kickback or damage to the saw chain.

If the saw chain does strike a foreign object, immediately stop the engine, inspect and repair the Power Pruner™ if necessary.

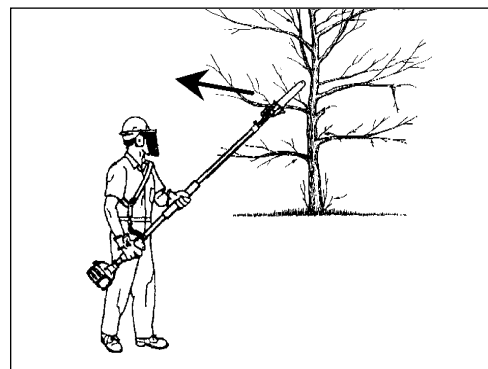

EQUIPMENT



WARNING

Serious injury may result from the use of non approved guide bar and saw chain combinations. ECHO, INC. will not be responsible for the failure of cutting devices or accessories which have not been tested and approved by ECHO for use with this unit. Read and comply with all safety instructions listed in this manual.

- Check unit for loose/missing nuts, bolts, and screws. Tighten and/or replace as needed.

Guide Bar and Saw Chain

- Check that the cutting attachment, guide bar, and saw chain is firmly attached and in safe operating condition.
- Use only one Echo-approved extension on the pruner.
- Do not hit rocks, stones, tree stumps, and other foreign objects with the saw chain.
- Do not cut into the ground with the saw chain.
- If cutting attachment end strikes an obstruction, stop engine immediately and inspect saw chain for damage.
- Do not operate with a dull, fractured, or discolored saw chain.
- Remove all foreign objects from work area.
- Always cover the guide bar and saw chain with guide bar cover during transportation and for storage.



WARNING

Moving parts can amputate fingers or cause severe injuries. Keep hands, clothing and loose objects away from all openings.

- **ALWAYS** stop engine, disconnect spark plug, and make sure all moving parts have come to a complete stop before removing obstructions, clearing debris, or servicing unit.
- **DO NOT** start or operate unit unless all guards and protective covers are properly assembled to unit.
- **NEVER** reach into any opening while the engine is running. Moving parts may not be visible through openings.



WARNING

Check fuel system for leaks due to fuel tank damage, especially if the unit is dropped. If damage or leaks are found, do not use unit, otherwise serious personal injury or property damage may occur. Have unit repaired by an authorized servicing dealer before using.

EMISSION CONTROL (EXHAUST & EVAPORATIVE)

EPA 2010 and Later and/or C.A.R.B. TIER III

The emission control system for the engine is EM/TWC (Engine Modification and 3-way Catalyst) and for the fuel tank the Control System is EVAP (Evaporative Emissions) or N (for nylon tank). Evaporative emission may be applicable to California models only.

EMISSION CONTROL INFORMATION
 ENGINE FAMILY: [E]EHXS.0454KA DISPLACEMENT: 45.0cc
 EMISSION COMPLIANCE PERIOD = 300 HOURS
 THIS ENGINE MEETS U.S. EPA EXH/EVP REGS FOR MODEL YEAR [E]****
 REFER TO OWNER'S MANUAL FOR MAINTENANCE SPECIFICATIONS AND ADJUSTMENTS.
YAMABIKO CORP. [E] [****]

EMISSION CONTROL INFORMATION
 ENGINE FAMILY: [E]EHXS.0214KG DISPLACEMENT: 21.2cc
 EMISSION COMPLIANCE PERIOD = 300 HOURS
 THIS ENGINE MEETS **** U.S. EPA EXH/EVP AND CALIFORNIA EXH AND EVP EMISSION REGULATIONS FOR S.O.R.E.
 REFER TO OWNER'S MANUAL FOR MAINTENANCE SPECIFICATIONS AND ADJUSTMENTS.
YAMABIKO CORP. [****] [E]

An Emission Control Label is located on the engine. (This is an EXAMPLE ONLY, information on label varies by engine FAMILY).

PRODUCT EMISSION DURABILITY (EMISSION COMPLIANCE PERIOD)

The 300 hour emission compliance period is the time span selected by the manufacturer certifying the engine emissions output meets applicable emissions regulations, provided that approved maintenance procedures are followed as listed in the Maintenance Section of this manual.

DESCRIPTION

Locate this safety decal on your unit. Make sure the decals are legible and that you understand and follow the instructions on them. If a decal cannot be read, a new one can be ordered from your ECHO dealer. See PARTS ORDERING instructions for specific information.

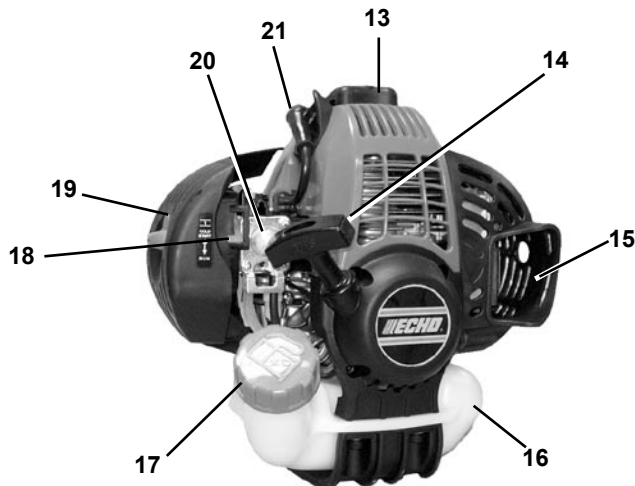

Hot Decal (near muffler)

P/N X505002310

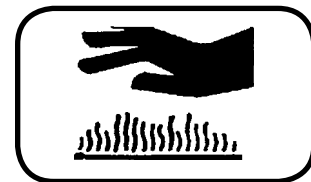

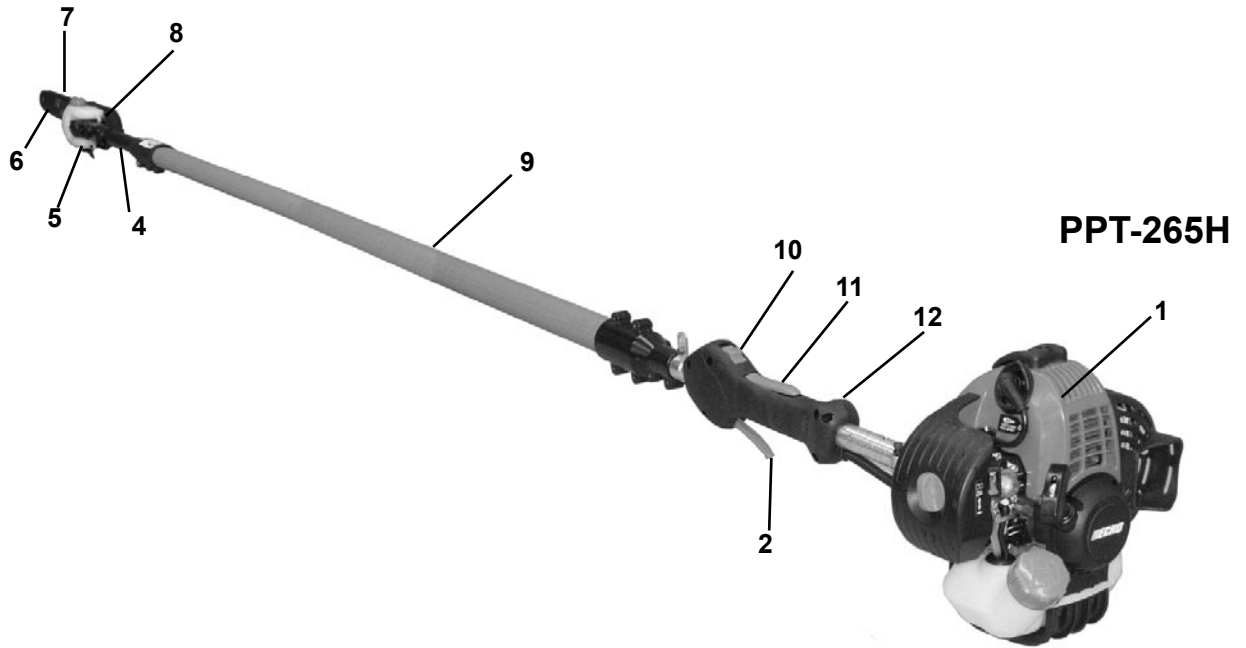
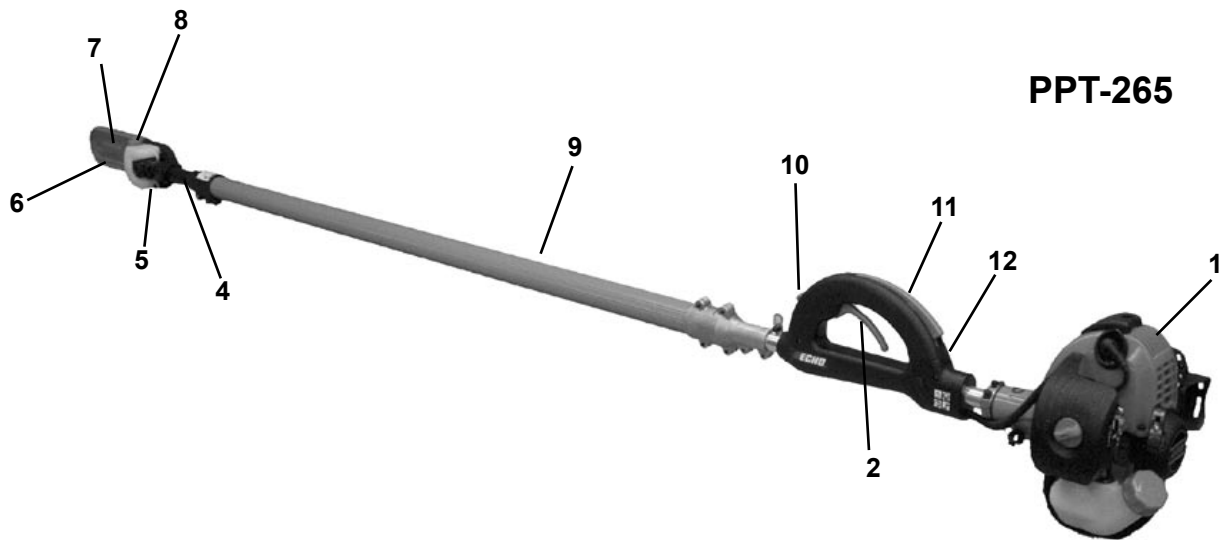

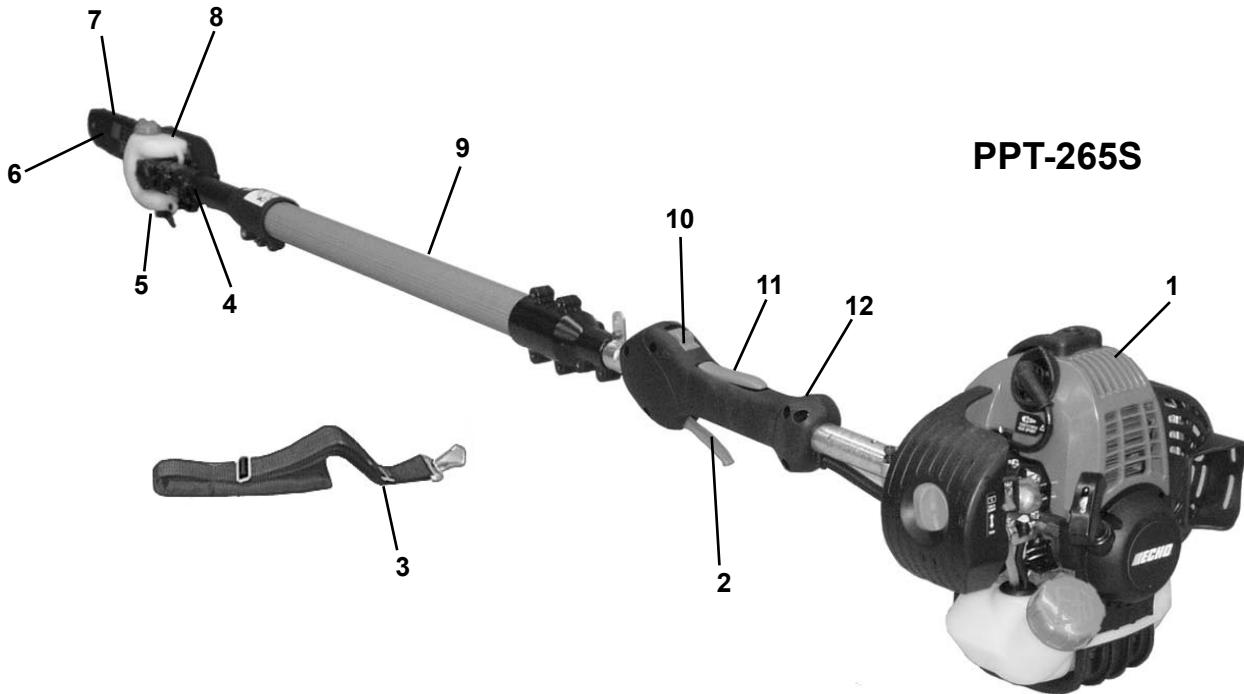



PPT-265S

P/N X505002371

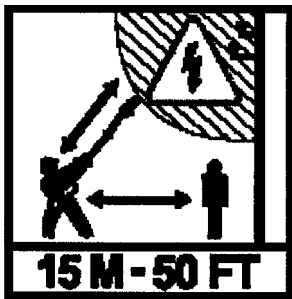
P/N X505002361



1. **POWER HEAD** - Includes the Engine, Clutch, Fuel System, Ignition System and Starter.
2. **THROTTLE TRIGGER** - Spring loaded to return to idle when released. During acceleration press trigger gradually for best operating technique.
3. **SHOULDER HARNESS** - An adjustable strap that suspends the unit from the operator.
4. **CUTTING ATTACHMENT** - Sealed, gear ratio is 1.5:1 reduction.
5. **CUTTING SHOE** - Used to capture and stabilize branch while cutting. Place cutting shoe against branch, accelerate and lower saw chain into branch.
6. **GUIDE BAR** - 305 mm (12 in.) guide bar w/chain tensioner.
7. **SAW CHAIN** - 91, 9.53 mm (3/8 in.) pitch, 0.050 gauge low profile Oregon® saw chain. Runs approximately 609.6 m/min. (2000 ft/min) at full throttle.
8. **AUTOMATIC OILER ASSEMBLY** - Self oiling. Use high quality, low viscosity, non detergent bar and chain oil.
9. **LOWER SHAFT TUBE** - Durable fiberglass mesh housing.
10. **STOP SWITCH** - Mounted on top of handle assembly. Move switch forward to run, back to stop.
11. **THROTTLE TRIGGER LOCKOUT** - This lever must be depressed before throttle trigger can be operated.
12. **REAR HANDLE ASSEMBLY** - Sturdy handle for right hand placement. Includes stop switch and throttle trigger.
13. **TOP GUARD** - Protects arm from hot engine.
14. **RECOIL STARTER** - Pull recoil handle slowly until starter engages, then quickly and firmly. When engine starts return handle slowly. **DO NOT** let handle snap back or damage will occur.
15. **SPARK ARRESTOR - CATALYTIC MUFFLER / MUFFLER** -The muffler or catalytic muffler controls exhaust noise and emission. The spark arrestor screen prevents hot, glowing particles of carbon from leaving the muffler. Keep exhaust area clear of flammable debris.
16. **FUEL TANK** - Contains fuel and fuel filter.
17. **FUEL TANK CAP** - Covers and seals fuel tank opening.
18. **CHOKE** - Located above air cleaner housing. Move lever to starting position () (close choke) and back to run position () (open choke).
19. **AIR CLEANER ASSEMBLY** - Contains replaceable air filter element.
20. **PURGE BULB** - Pumping purge bulb before starting engine draws fresh fuel from the fuel tank, purging air from the carburetor. Pump purge bulb until fuel is visible and flows freely in the clear fuel tank return line. Pump purge bulb an additional 4 or 5 times.
21. **SPARK PLUG** - Provides spark to ignite fuel mixture.
22. **GUIDE BAR COVER** - Used to cover guide bar and saw chain during transport and storage. Remove guide bar cover before using unit.

CONTENTS

Due to packaging restriction the ECHO product you have purchased requires some assembly. After opening the carton, check for damage. Immediately notify your retailer or ECHO Dealer of damaged or missing parts. Use the contents list to check for missing parts.

- ___ Power Head
- ___ Handle Shaft Assembly (PPT-265 Only)
- ___ Drive Shaft Assembly
- ___ Cutting Attachment W/ Guide Bar and Saw Chain
- ___ Operator's Manual
- ___ Safety Manual
- ___ Warranty Registration Card
- ___ Assembly Tool (s)
- ___ Safety Glasses
- ___ Shoulder Harness
- ___ Guide Bar Cover

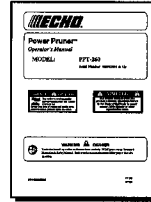

ASSEMBLY

Parts Required: Power Head, Handle Shaft Assembly, Drive Shaft Assembly, Cutting Attachment

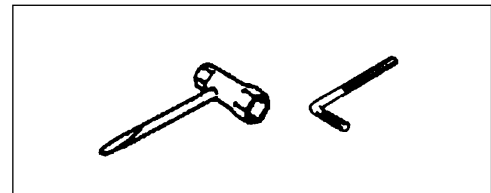

HANDLE SHAFT / DRIVE SHAFT (PPT-265 Model Only)

1. Remove protective caps from handle shaft assembly.
2. Loosen clamping bolts (A) on drive shaft.
3. Pull flexible drive shaft coupler (B) 2 -3 inches out of handle shaft.

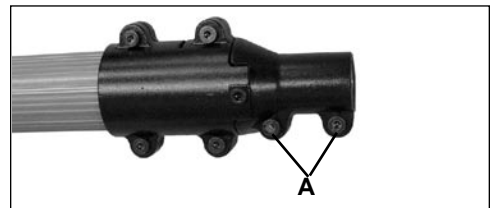

4. Align flexible drive shaft coupler with drive shaft socket and slide together until handle shaft is fully seated into drive shaft.
5. Tighten clamping bolts (A).

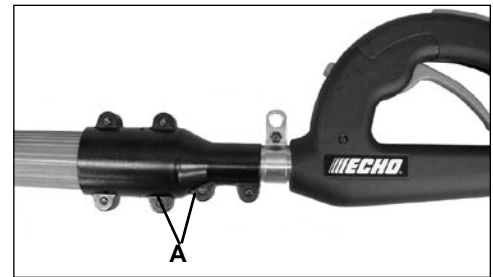

HANDLE SHAFT / POWER HEAD

1. Loosen two (2) clamping screws (A) and remove locating screw (B).
2. Pull flexible drive shaft coupler (C) 2-3 in. out of drive shaft assembly.
3. Align flexible drive shaft coupler with engine socket and slide together until locating hole in shaft is visible through locating hole in engine housing.
4. Install locating screw (B) and tighten clamping bolts (A).

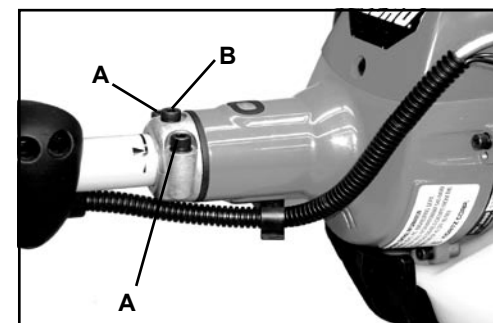
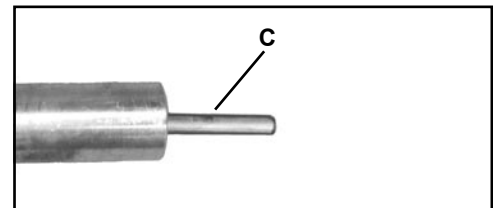
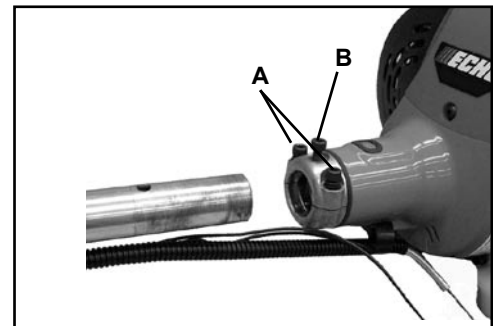

THROTTLE LINKAGE AND IGNITION LEADS

1. Install throttle linkage cable into fan cover clip (A).
2. Close choke and remove air filter cover.
3. Place throttle linkage (B) through adjustment fixture (C) and install wire end into large carburetor throttle swivel hole (D). Check throttle for freedom of movement and that wide open throttle / low idle extremes are adjusted properly. The throttle linkage must be adjusted by moving the adjustment fixture (C). Consult with your Echo Dealer for correct adjustment procedure.
4. Connect 2 ignition stop leads (E, F) from throttle cable tubing to 2 ignition leads (E, F) on engine.

CAUTION:

Assure ignition terminals are completely covered by clear plastic sleeves.

5. Secure ignition leads against engine housing with clip (G).
6. Install air filter and cover.

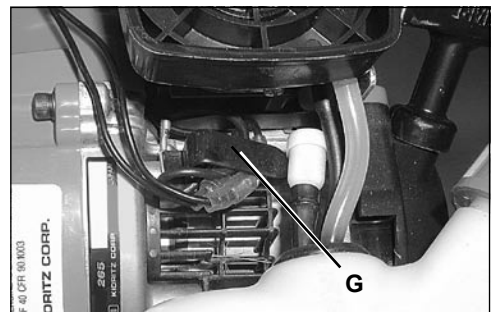
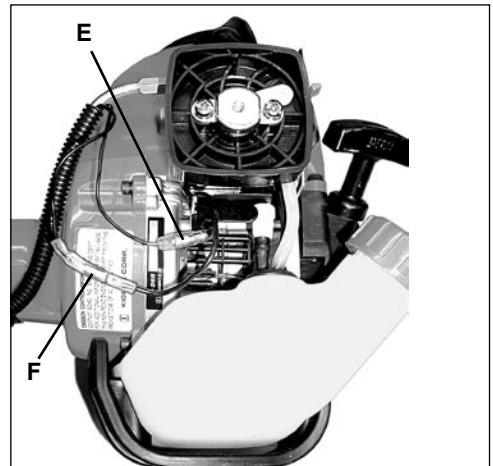
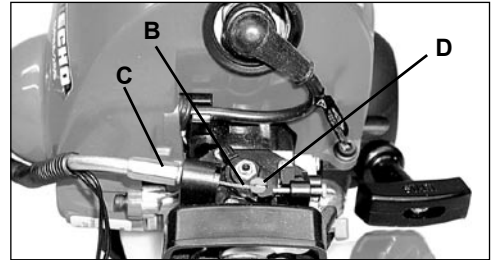
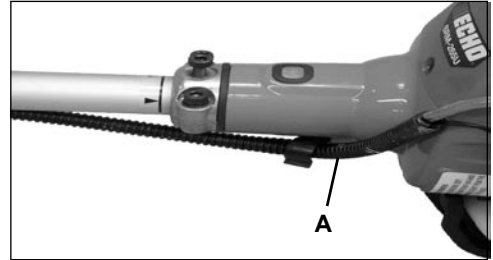

CUTTING ATTACHMENT TO DRIVE SHAFT INSTALLATION



WARNING

Saw Chain is sharp! Always wear gloves when handling assembly, otherwise serious personal injury may result.

1. Loosen the two (2) screws (C) and locator screw (D) on cutting attachment.
2. Loosen clamp knob (E) turning counter clockwise.
3. Pull upper tube (F) out of fiberglass lower tube 127-152 mm (5-6 in.), then slide (F) back into fiberglass lower tube exposing inner drive shaft (G). Align and join star shaped drive end of inner drive shaft (G) with cutting attachment shaft (H).
4. Align ridges (J) on upper tube with seams in cutting attachment.
5. Slide together aligning locator screw (D) in cutting attachment with locating hole (I) in upper tube.
6. Tighten locator screw (D). Tighten two (2) cutting attachment screws (C).
7. Extend upper tube to desired length. Tighten clamp knob (E) turning clockwise.

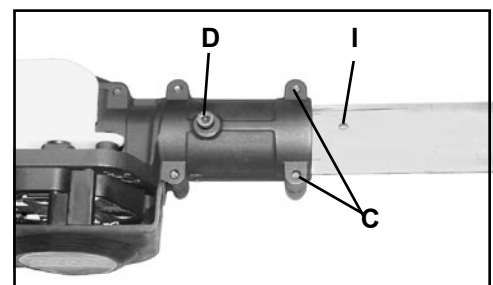
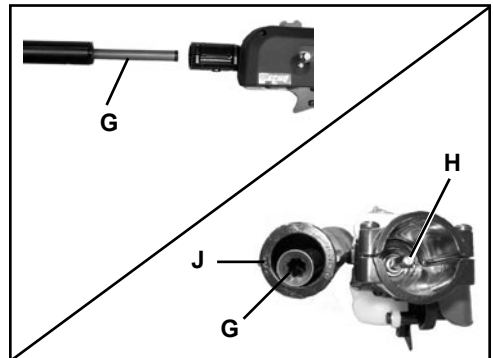
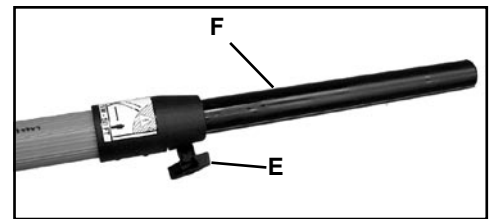
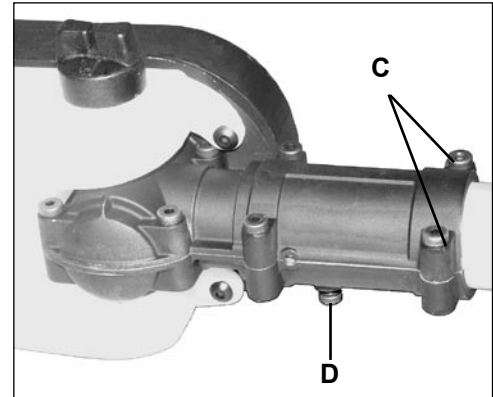

SAW CHAIN TENSION ADJUSTMENT



WARNING

Always disconnect spark plug wire before servicing cutting attachment. Wear gloves when handling saw chain, otherwise serious personal injury may result.

To Adjust Saw Chain Tension

1. Move stop switch to STOP position.
2. Disconnect spark plug lead.
3. Loosen two guide bar cover nuts (A) until finger tight.
4. Hold the bar nose up, and turn the adjuster screw (B) clockwise until the chain fits snugly against the underside of the bar, as shown. Cold Chain Only - turn adjuster screw CW an additional 1/8 - 1/4 turn.
5. Tighten both guide bar cover nuts with nose held up. Tighten rear nut first.
6. Pull the chain around the guide bar by hand. Reduce the chain tension if you feel tight spots.
7. When chain is properly tensioned, tighten guide bar cover nuts securely.

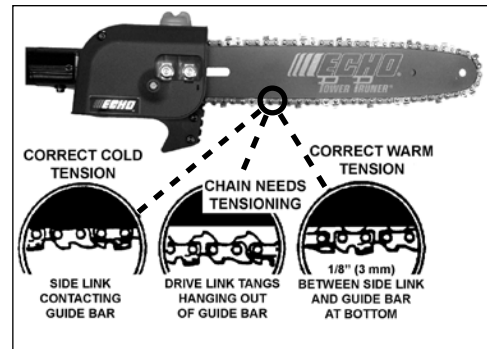
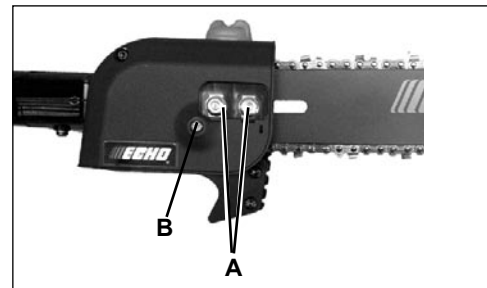

IMPORTANT

Tighten guide bar cover nuts to 8 - 9 N•m (71 - 80 in. lbs.) DO NOT over-tighten nuts. Damage may result.

8. Keep chain properly tensioned at all times.

NOTE

All chains require frequent adjustment.

9. Connect spark plug lead.

OPERATION



WARNING

Moving parts can amputate fingers or cause severe injuries. Keep hands, clothing and loose objects away from all openings. Always stop engine, disconnect spark plug, and make sure all moving parts have come to a complete stop before removing obstructions, clearing debris, or servicing unit.



WARNING

Operation of this equipment may create sparks that can start fires around dry vegetation. This unit is equipped with a spark arrestor and a spark arrestor may be required. The operator should contact local fire agencies for laws or regulations relating to fire prevention requirements.

FUEL

NOTICE: Use of unmixed, improperly mixed, or fuel older than 90 days, (stale fuel), may cause hard starting, poor performance, or severe engine damage and void the product warranty. Read and follow instructions in the Storage section of this manual.



WARNING

Alternative fuels, such as E-15 (15% ethanol), E-85 (85% ethanol) or any fuels not meeting ECHO requirements are **NOT** approved for use in ECHO 2-stroke gasoline engines. Use of alternative fuels may cause performance problems, loss of power, overheating, fuel vapor lock, and unintended machine operation, including, but not limited to, improper clutch engagement. Alternative fuels may also cause premature deterioration of fuel lines, gaskets, carburetors and other engine components.

Fuel Requirements

Gasoline - Use 89 Octane [R+M/2] (mid grade or higher) gasoline known to be good quality. Gasoline may contain up to 10% Ethanol (grain alcohol) or 15% MTBE (methyl tertiary-butyl ether). Gasoline containing methanol (wood alcohol) is **NOT** approved.

Two Stroke Oil - A two-stroke engine oil meeting ISO-L-EGD (ISO/CD 13738) and J.A.S.O. FD Standards must be used. Echo brand premium Power Blend X™ Universal 2-Stroke Oil meets these standards. Engine problems due to inadequate lubrication caused by failure to use an (ISO/CD 13738) and J.A.S.O. FD certified oil, such as Echo premium Power Blend X™, will void the two-stroke engine warranty.

IMPORTANT

Echo premium Power Blend X™ Universal 2-Stroke Oil may be mixed at 50:1 ratio for application in all Echo engines sold in the past regardless of ratio specified in those manuals.

Handling Fuel



DANGER

Fuel is VERY flammable. Use extreme care when mixing, storing or handling or serious personal injury may result.

- Use an approved fuel container.
- DO NOT smoke near fuel.
- DO NOT allow flames or sparks near fuel.
- Fuel tanks/cans may be under pressure. Always loosen fuel caps slowly allowing pressure to equalize.
- NEVER refuel a unit when the engine is HOT or RUNNING!
- DO NOT fill fuel tanks indoors. ALWAYS fill fuel tanks outdoors over bare ground.
- DO NOT overfill fuel tank. Wipe up spills immediately.
- Securely tighten fuel tank cap and close fuel container after refueling.
- Inspect for fuel leakage. If fuel leakage is found, do not start or operate unit until leakage is repaired.
- Move at least 3m (10 ft.) from refueling location before starting the engine.

Mixing Instructions

1. Fill an approved fuel container with half of the required amount of gasoline.
2. Add the proper amount of 2-stroke oil to gasoline.
3. Close container and shake to mix oil with gasoline.
4. Add remaining gasoline, close fuel container, and remix.

Fuel to Oil Mix - 50:1 Ratio			
U.S.		METRIC	
GAS	OIL	GAS	OIL
Gallons	Fl. oz.	Liter	cc.
1	2.6	4	80
2	5.2	8	160
5	13	20	400

IMPORTANT

Spilled fuel is a leading cause of hydrocarbon emissions. Some states may require the use of automatic fuel shut-off containers to reduce fuel spillage.

After use

- DO NOT store a unit with fuel in its tank. Leaks can occur. Return unused fuel to an approved fuel storage container.

Storage - Fuel storage laws vary by locality. Contact your local government for the laws affecting your area. As a precaution, store fuel in an approved, airtight container. Store in a well-ventilated, unoccupied building, away from sparks and flames.

IMPORTANT

Stored fuel ages. Do not mix more fuel than you expect to use in thirty (30) days, ninety (90) days when a fuel stabilizer is added.

IMPORTANT

Stored two-stroke fuel may separate. ALWAYS shake fuel container thoroughly before each use.

LUBRICATING THE GUIDE BAR AND SAW CHAIN

Automatic Oiling System

1. Wipe debris from around oil fill cap.
2. Remove oil fill cap and fill reservoir with a quality, low viscosity guide bar and saw chain oil.

NOTE

The discharge volume of the automatic oiler is preset to deliver 3 to 4 cc/min. at normal operating RPM. During heavy or dry cutting conditions the oil discharge volume may be adjusted to assure adequate lubrication. Refill the oil reservoir with each tank of fuel.

IMPORTANT

To prevent plastic deterioration, do not use synthetic or silicone based oil.



ADJUSTING AUTOMATIC OILER

1. From bottom of gear case, turn adjustment screw (A) clockwise to decrease oil volume - counter clockwise to increase oil volume.

NOTE

Very little visible oil on the saw chain will provide sufficient lubrication.

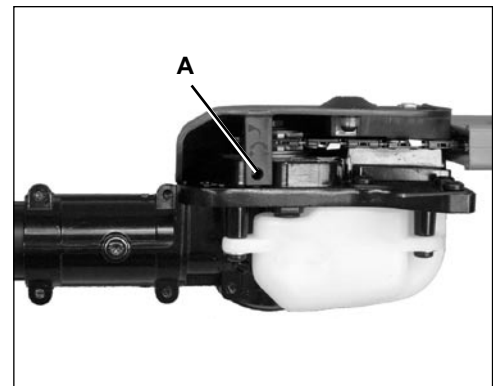

STARTING COLD ENGINE



WARNING

The attachment will operate immediately when the engine starts and could result in loss of control and possible serious injury. Keep movable parts of the attachment off the ground and away from objects that could become entangled or thrown.

1. *Stop Switch*
Move stop switch button (A) forward away from the STOP position.
2. *Choke*
Move choke (B) to “Cold Start” (I) Position.
3. *Purge Bulb*
Pump purge bulb (C) until fuel is visible and flows freely in the clear fuel tank return line. Pump bulb an additional 4 or 5 times.
4. *Recoil Starter*
Lay the unit on a flat, area and keep movable attachment parts clear of all obstacles. Firmly grasp right hand grip and throttle trigger lockout with left hand and fully depress throttle trigger to wide open position. Rapidly pull recoil starter handle/rope (D) until engine fires (or maximum five [5] pulls).
5. *Choke*
After engine fires (or five [5] pulls), move choke lever back to “Run” (R) position. Hold throttle trigger and throttle trigger lockout fully depressed and pull recoil starter handle/rope until engine starts and runs. Release throttle trigger and allow unit to warm up at idle for several minutes.

NOTE

If engine does not start with choke in “Run” position after 5 pulls, repeat instructions 2 - 5.

6. After engine warms up, gradually depress throttle trigger to increase engine RPM to operating speed.

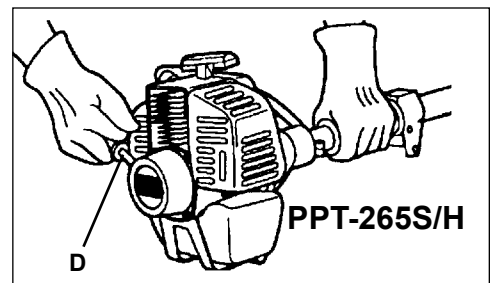
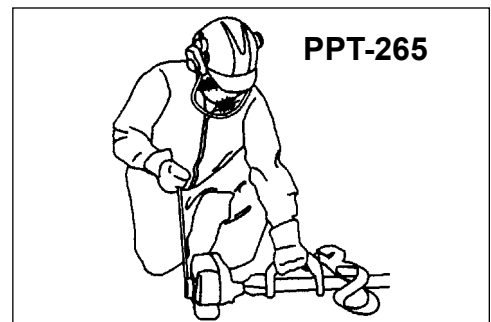
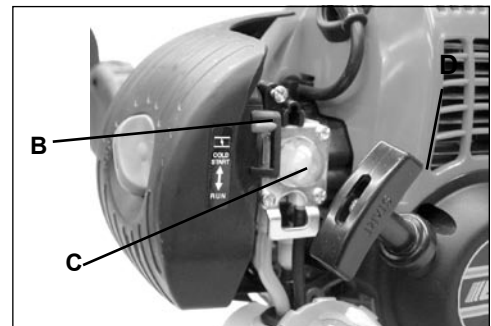
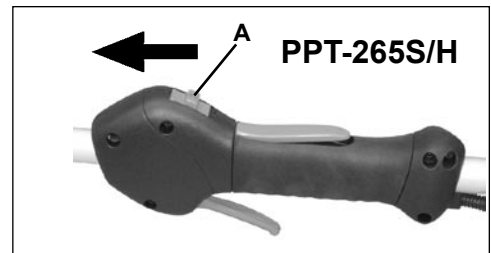

STARTING WARM ENGINE

The starting procedure is the same as Cold Start except DO NOT close the choke, and do not depress throttle trigger to wide open position.



WARNING

The attachment should not move at idle, otherwise serious personal injury may result.

NOTE

If attachment moves, readjust carburetor according to "Carburetor Adjustment" instructions in this manual or see your ECHO Dealer.

1. *Stop Switch.*
Move Stop Switch button (A) forward away from the STOP position.
2. *Purge Bulb*
Pump purge bulb (C) until fuel is visible and flows freely in the clear fuel tank return line. Pump bulb an additional 4 or 5 times.
3. *Recoil Starter.*
Lay the unit on a flat, clear area and firmly grasp right hand grip with left hand. Do not depress throttle trigger. Pull the recoil starter handle (D) until the engine fires.

NOTE

If engine does not start after 5 pulls, use Cold Start Procedure.

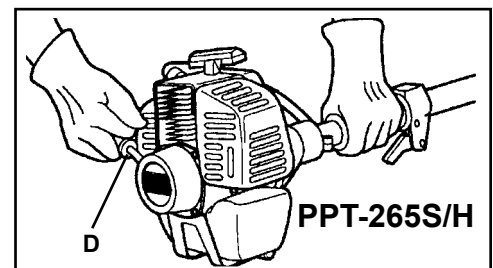
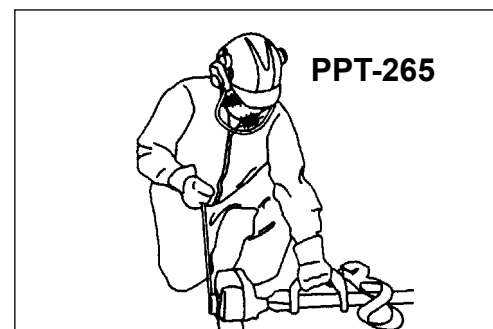
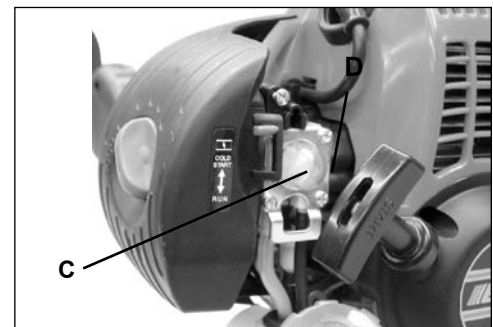
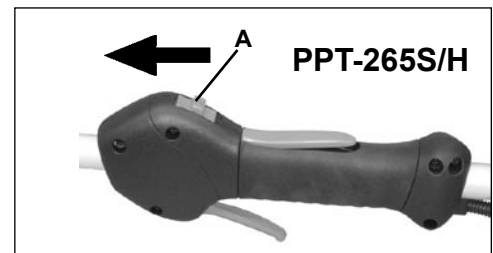

STOPPING ENGINE

1. *Throttle.*
Release throttle trigger, and allow engine to return to idle before stopping engine.
2. *Stop Switch.*
Move stop switch button (A) backward to STOP position.



WARNING

If engine does not stop when stop switch is moved to STOP position, close choke - COLD START position - to stall engine. Have your ECHO dealer repair stop switch before using pruner again.

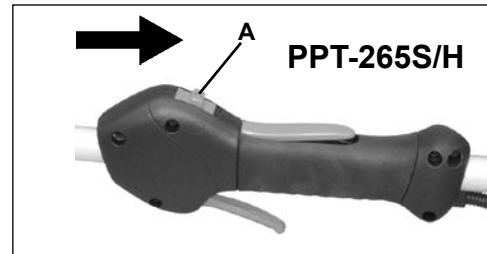

PRUNING TECHNIQUES



WARNING

Engine exhaust IS HOT, and contains Carbon Monoxide (CO), a poison gas. Breathing CO can cause unconsciousness, serious injury, or death. Exhaust can cause serious burns. ALWAYS position unit so that exhaust is directed away from your face and body.

The Power Pruner™ is designed for light to medium trimming of limbs and branches up to 203 mm (8 in.) in diameter. Follow these tips for successful operation.

- Plan cut carefully. Check direction branch will fall.
- Plan retreat path from falling branch. Cut branches bounce when striking ground.
- Long branches should be removed in several pieces.
- Do not stand directly beneath branch being cut.
- When ready to cut:
Hold "cutting shoe" against branch. This will prevent whipping of the branch. DO NOT use back and forth sawing action.
- Look out for branch immediately behind the branch being cut. If saw chain hits rear branch damage to saw chain may occur.
- Accelerate to full throttle.
- Apply cutting pressure.
- Ease cutting pressure when nearing end of cut to maintain control.
- When pruning a limb 102 mm (4 in.) diameter or larger cut as follows:
 1. Under cut 1/4 limb diameter near tree trunk.
 2. Finish top cut slightly farther out on limb.
 3. Flush cut stub at trunk.
- DO NOT use for felling or bucking.

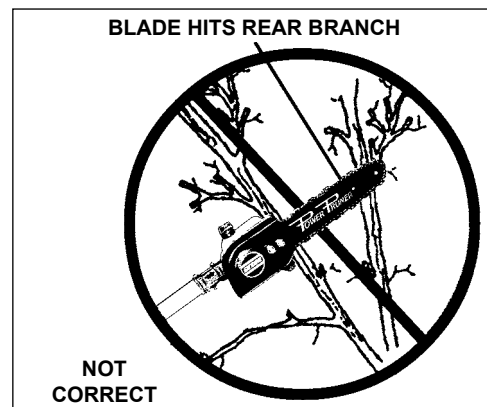
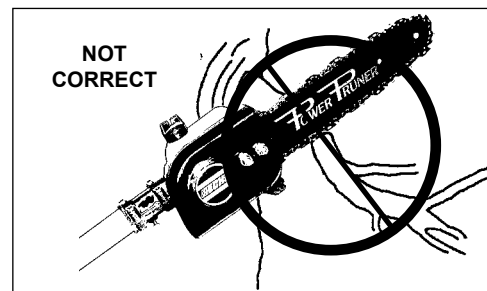
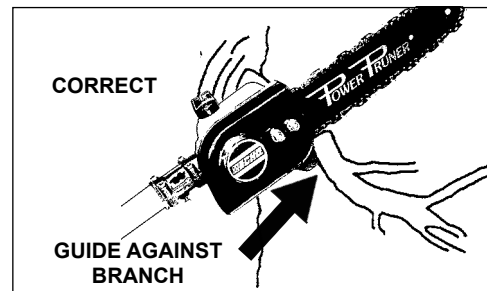

MAINTENANCE



WARNING

Moving parts can amputate fingers or cause severe injuries. Keep hands, clothing and loose objects away from all openings. Always stop engine, disconnect spark plug, and make sure all moving parts have come to a complete stop before removing obstructions, clearing debris, or servicing unit.

Your ECHO Power Pruner™ is designed to provide many hours of trouble free service. Regular scheduled maintenance will help your pruner achieve that goal. If you are unsure or are not equipped with the necessary tools, you may want to take your unit to an ECHO Service Dealer for maintenance. To help you decide whether you want to DO-IT-YOUR-SELF or have the ECHO Dealer do it, each maintenance task has been graded. If the task is not listed see your ECHO Dealer for repairs.

SKILL LEVEL

- Level 1 = Easy to do. Common tools may be required.
- Level 2 = Moderate difficulty. Some specialized tools may be required.

ECHO offers **REPOWER™** Maintenance Kits and Parts to make your maintenance job easier.

MAINTENANCE INTERVALS

COMPONENT / SYSTEM	MAINTENANCE PROCEDURE	REQ'D SKILL LEVEL	DAILY OR BEFORE USE	EVERY REFUEL	3 MONTHS OR 90 HOURS	YEARLY 600 HOURS
Air Filter	Inspect/Clean	1	I / C *		R *	
Choke Shutter	Inspect/Clean	1	I / C			
Fuel Filter	Inspect/Replace	1			I *	I / R *
Fuel Cap Gasket	Inspect/Replace	1			I *	R *
Fuel System	Inspect/Replace	1	I (2) *	I (2) *		
Spark Plug	Inspect/Clean/Replace	1			I/C/R *	
Cooling System	Inspect/Clean	2	I / C			
Muffler Spark Arrestor	Inspect/Clean/Replace	2			I/C/R *	
Cylinder Exhaust Port	Inspect/Clean/Decarbon	2			I / C	
Drive Shaft (Flex Cable Models)	Inspect/Grease	2			I (1)	
Guide Bar / Sprocket Nose	Inspect/Clean/Lubricate	2	I / C *	I		
Saw Chain	Inspect/Sharpen/Replace/Tension	2	I *	I *		
Recoil Starter Rope	Inspect/Clean	1	I / C *			
Screws/Nuts/Bolts	Inspect/Tighten/Replace	1	I *			

MAINTENANCE PROCEDURE LETTER CODES: I = INSPECT, R = REPLACE, C = CLEAN

IMPORTANT NOTE - Time intervals shown are maximum. Actual use and your experience will determine the frequency of required maintenance.

MAINTENANCE PROCEDURE NOTES:

(1) Apply POWER BLENDX™ lubricant every 25 hours of use.

(2) Low evaporative fuel tanks DO NOT require regular maintenance to maintain emission integrity.

* All recommendations to replace are based on the finding of damage or wear during inspection.

AIR FILTER

Level 1.

Parts required: REPOWER™ AIR & FUEL FILTER KIT.

1. Close choke (Cold Start Position []). This prevents dirt from entering the carburetor throat when the air filter is removed. Brush accumulated dirt from air cleaner area.
2. Remove air filter cover. Brush dirt from inside cover.
3. Remove air filter and lightly brush debris from filter. Replace filter if it is damaged, fuel soaked, very dirty, or the rubber sealing edges are deformed.
4. If filter can be reused, be certain it:
 - Fits tightly in the air filter cavity.
 - Is installed with the original side out.
5. Install air filter cover.

NOTE

Carburetor adjustment may be needed after air filter cleaning/replacement. See Carburetor Adjustment Section.



FUEL FILTER

Level 1.

Parts Required: REPOWER™ AIR & FUEL FILTER KIT.



DANGER

Fuel is **VERY** flammable. Use extreme care when mixing, storing or handling or serious personal injury may result.

1. Use a clean rag to remove loose dirt from around fuel cap and empty fuel tank.
2. Use the “fuel line hook” to pull the fuel line and filter from the tank.
3. Remove the filter from the line and install the new filter.



SPARK PLUG

Level 2.

Parts Required: REPOWER™ Tune-Up Kit

IMPORTANT

Use only NGK BPM-8Y spark plug (BPMR-8Y in Canada) otherwise severe engine damage may occur.

1. Remove spark plug and check for fouling, worn and rounded center electrode.
2. Clean the plug or replace with a new one. DO NOT sand blast to clean. Remaining sand will damage engine.
3. Adjust spark plug gap 0.65mm (0.026 in.) by bending outer electrode.
4. Tighten spark plug to 150-170 kgf • cm (130-150 in • lbf).

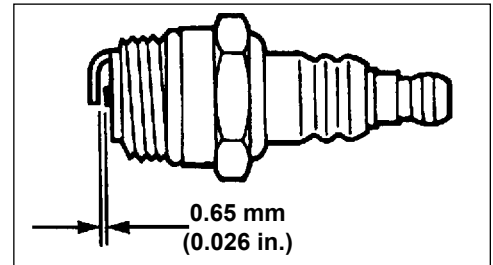

COOLING SYSTEM CLEANING

Level 2.

Parts Required: None.

IMPORTANT

To maintain proper engine operating temperatures, cooling air must pass freely through the cylinder fin area. This flow of air carries combustion heat away from the engine.

Overheating and engine seizure can occur when:

- Air intakes are blocked, preventing cooling air from reaching the cylinder.
- Dust and grass build up on the outside of the cylinder. This build up insulates the engine and prevents the heat from leaving.

Removal of cooling passage blockages or cleaning of cooling fins is considered "Normal Maintenance." Any failure attributed to lack of maintenance is not warranted.



1. Remove spark plug lead.
2. Remove air cleaner cover.
3. Remove muffler cover screw and muffler cover (A).
4. Remove 2 engine cover screws and engine cover (B).

IMPORTANT

DO NOT use a metal scraper to remove dirt from the cylinder fins.

5. Use brush to remove dirt from the cylinder fins.
6. Remove grass and leaves from the grid between the recoil starter and fuel tank.
7. Assemble components in reverse order.

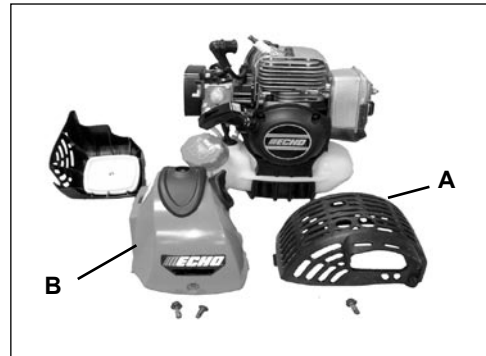

EXHAUST SYSTEM

Spark Arrestor Screen

Level 2.

Parts Required: Spark Arrestor Screen, Gasket

1. Remove muffler cover screw and muffler cover (A).
2. Place piston at Top Dead Center (TDC) to prevent carbon/dirt from entering cylinder.
3. Remove spark arrestor screen (B), gasket (C) and exhaust guide (D) from muffler body.
4. Clean carbon deposits from muffler components.

NOTE

When cleaning carbon deposit, be careful not to damage the catalytic element inside muffler.

5. Replace screen if it is cracked, plugged or has holes burned through.
6. Assemble components in reverse order.

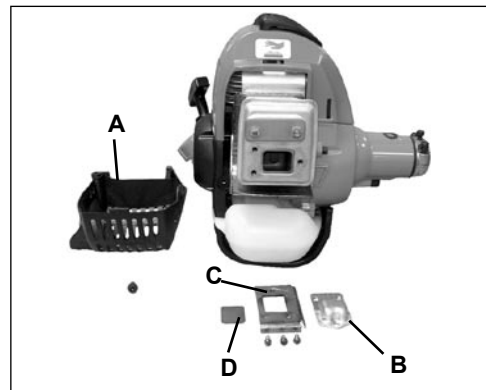

Exhaust Port Cleaning

Level 2.

Parts Required: As needed: Heat Shield

1. Remove spark plug lead from spark plug, and remove muffler cover (1 screw).
2. Place piston at top dead center. Remove muffler (A) and heat shield (B).
3. Use a wood or plastic scraping tool to clean deposits from cylinder exhaust port.

IMPORTANT

Never use a metal tool to scrape carbon from the exhaust port. Do not scratch the cylinder or piston when cleaning the exhaust port. Do not allow carbon particles to enter the cylinder.

4. Inspect heat shield, and replace if damaged.
5. Install heat shield and muffler.
6. Tighten muffler mounting bolts (or nuts) to 60-70 in•lbf (70-80 kgf•cm).
7. Install muffler cover and attach spark plug lead.
8. Start engine, and warm to operating temperature.
9. Stop engine, and re-tighten mounting bolts (or nuts) to specifications.

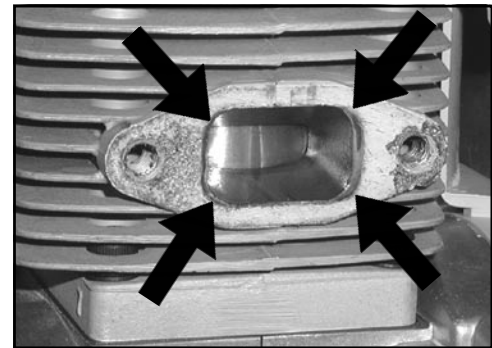
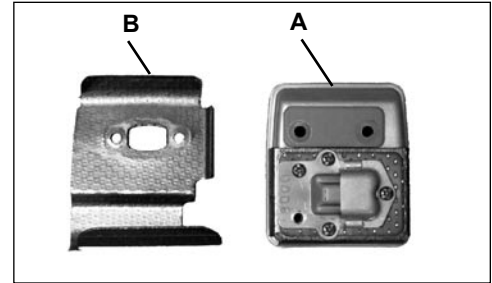

CARBURETOR ADJUSTMENT

Engine Break-In

New engines must be operated a minimum duration of two tanks of fuel break-in before carburetor adjustments can be made. During the break-in period your engine performance will increase and exhaust emissions will stabilize. Idle speed can be adjusted as required.

High Altitude Operation

This engine has been factory adjusted to maintain satisfactory starting, emission, and durability performance up to 1,100 feet above sea level (ASL) (96.0 kPa). To maintain proper engine operation and emission compliance above 1,100 feet ASL the carburetor may need to be adjusted by an authorized ECHO service dealer.

IMPORTANT

If the engine is adjusted for operation *above* 1,100 feet ASL, the carburetor must be re-adjusted when operating the engine *below* 1,100 feet ASL, otherwise severe engine damage may result.

Level 2.

Parts required: None.

NOTE

Every unit is run at the factory and the carburetor is set in compliance with emission regulations. Carburetor adjustments, other than idle speed, must be performed by an authorized ECHO dealer.

1. Check idle speed and reset if necessary. If a tachometer is available, idle speed screw (A) should be set to the specifications found on page 34 "Specifications" of this manual. Turn idle screw (A) clockwise to increase idle speed; counter clockwise to decrease idle speed.



WARNING

When carburetor adjustment is completed, the cutting attachment should not turn at idle, otherwise serious personal injury may result.



GUIDE BAR AND SAW CHAIN REPLACEMENT



WARNING

Never try to replace or adjust guide bar and saw chain with engine running. Always disconnect spark plug wire before servicing guide bar and saw chain. This saw chain is **VERY** sharp, wear heavy gloves to protect your hands when handling it. Wear eye protection meeting CE or ANSI specification Z87.1.

Guide Bar Replacement / Installation

Level 2

1. Remove two (2) 6 mm guide bar nuts (A) and guide bar cover screw (B), and turn saw chain tension adjustment screw (C) counterclockwise to release tension.
2. Remove guide bar cover (D).
3. Remove guide bar and saw chain from gear case and sprocket.
4. Remove chain from guide bar and check guide bar for damage and excessive or uneven wear. Replace guide bar if necessary.
5. Install chain on guide bar with cutters on top of bar facing toward bar tip.
6. Install guide bar and chain on gear case, engaging chain with drive sprocket (E).
7. Turn tension adjustment screw clockwise to take up slack in saw chain.
8. Install guide bar cover (D), and tighten guide bar nuts finger tight and install guide bar cover screw (B).
9. Adjust chain tension.

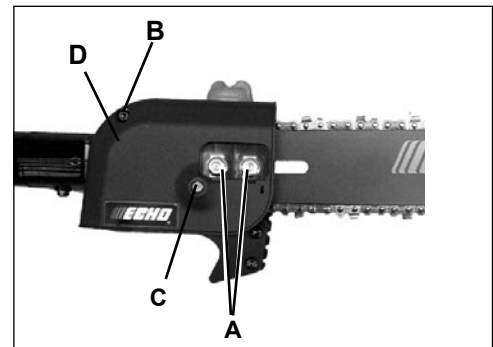
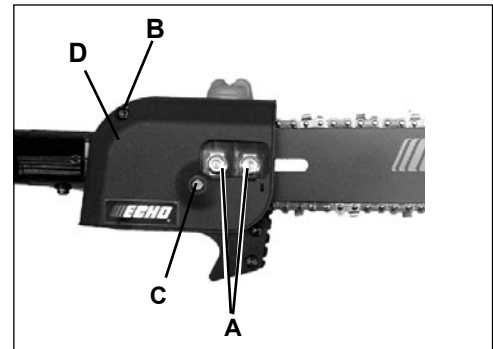

Guide Bar Cover Cleaning

1. Remove two (2) 6 mm guide bar nuts (A) and guide bar cover screw (B).
2. Remove guide bar cover (D).
3. Gently brush debris from inside guide bar cover and from around sprocket.
4. Install guide bar cover (D), install and tighten guide bar nuts, and install guide bar cover screw (B).

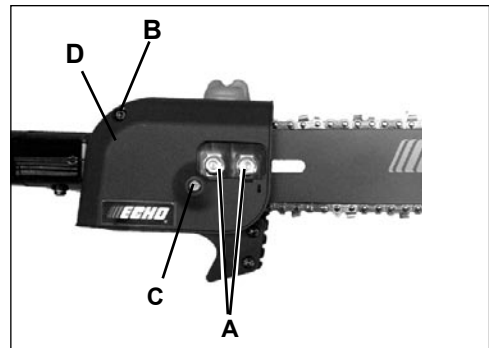

To Adjust Saw Chain Tension

1. Move stop switch to STOP position.
2. Disconnect spark plug lead.
3. Loosen two gearcase cover nuts (A) until finger tight.
4. Hold the bar nose up, and turn the adjuster screw (B) clockwise until the chain fits snugly against the underside of the bar, as shown. Cold Chain Only - turn adjuster screw CW an additional 1/8 - 1/4 turn.
5. Tighten both guide bar cover nuts with nose held up. Tighten rear nut first.
6. Pull the chain around the guide bar by hand. Reduce the chain tension if you feel tight spots.
7. When chain is properly tensioned, tighten gear case cover nuts securely.

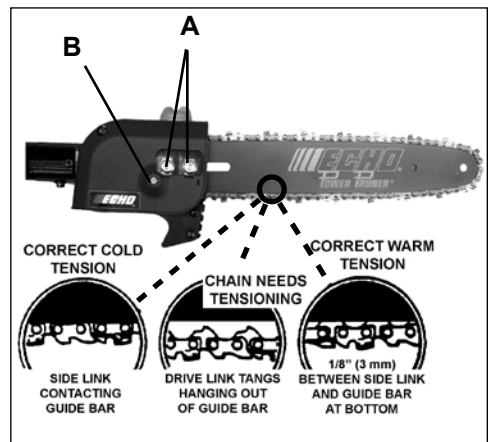

IMPORTANT

Tighten guide bar cover nuts to 8 - 9 N•m (71 - 80 in. lbs.) DO NOT over-tighten nuts. Damage may result.

8. Keep chain properly tensioned at all times.

NOTE

All chains require frequent adjustment.

9. Connect spark plug lead.

PPT-265 Power Pruner B&C Combinations						
	Bar P/N	Chain P/N	Chain Type	Links	Pitch	Gauge
Standard						
	12" Regular Bar P/N 12A OCD3744	M91VX44G	91	44	3/8"	.050
Optional						
	10" Regular Bar P/N 10A OCD3739	M91VX39G	91	39	3/8"	.050
	14" Regular Bar P/N 14A OCD3749	M91VX49G	91	49	3/8"	.050
Narrow Kerf						
	10" Narrow Bar P/N 10A4CD3739	90SG39G	90	39	3/8"	.043
	12" Narrow Bar P/N 12A4CD3744	90SG44G	90	44	3/8"	.043
	14" Narrow Bar P/N 14A4CD3749	90SG49G	90	49	3/8"	.043

IMPORTANT

Chain and guide bar gauge size must be identical. Use Bar/Chain combinations shown in table above.

FILING SAW CHAIN

Level 2.

IMPORTANT

Dull or damaged cutters will result in poor cutting performance, increased vibration, and premature saw chain failure.



WARNING

Always stop engine and disconnect spark plug wire before servicing guide bar and saw chain. Always wear gloves when filing saw chain, otherwise serious personal injury may result.

1. Set round file (A) in cutter at 30° angle. One fifth (1/5) of the file should be exposed above top cutter edge.
2. Keep file horizontal in cutter and file in one direction.
3. File until cutter top and side bevel edges are sharp without nicks.
4. Place depth gauge tool (B) firmly on top of cutter with .025 in. slot and end against front cutter raker. File cutter raker with flat file until flush with top of depth gauge.
5. Finish cutter sharpening by rounding front raker edge (C) with flat file.
6. Properly filed cutter is as shown.
7. Apply clean oil and rotate saw chain slowly to wash away filings.
8. If saw chain is coated or clogged with resin, clean in kerosene, then soak in oil.

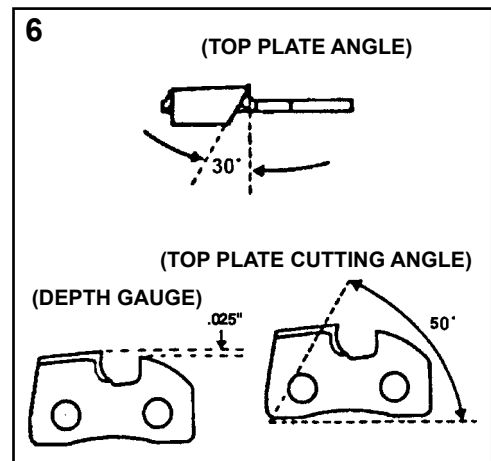
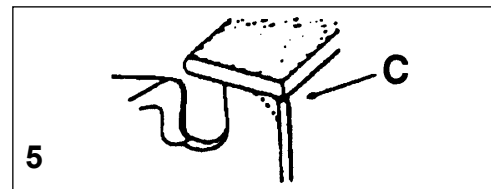
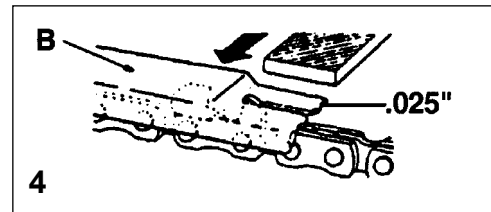
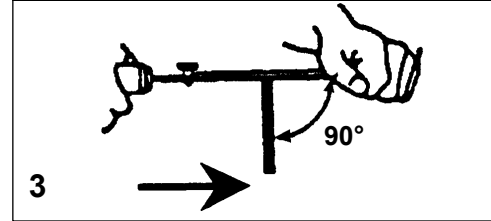
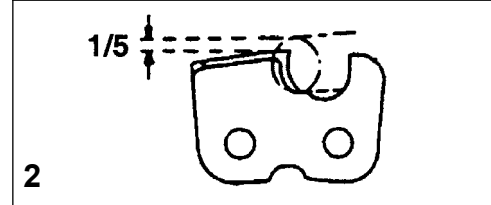
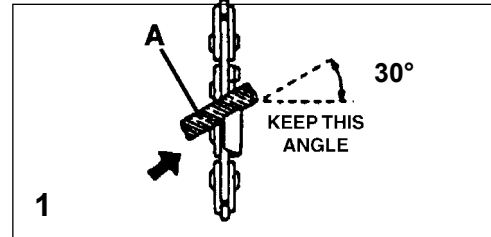

TROUBLESHOOTING

ENGINE PROBLEM TROUBLESHOOTING CHART				
Problem	Check	Status	Cause	Remedy
Engine cranks - starts hard/ doesn't start	Fuel at carburetor	No fuel at carburetor	Fuel strainer clogged Fuel line clogged Carburetor	Clean or replace Clean or replace See your Echo dealer
	Fuel at cylinder	No fuel at cylinder	Carburetor	See your Echo dealer
		Muffler wet with fuel	Fuel Mixture too rich	Open choke Clean/replace air filter Adjust carburetor See your Echo dealer
	Spark at end of plug wire	No spark	Stop switch off Electrical problem Interlock switch	Turn switch to ON See your Echo dealer See your Echo dealer
	Spark at plug	No spark	Spark gap incorrect Covered with carbon Fouled with fuel Plug defective	Adjust to .65mm (0.026 in.) Clean or replace Clean or replace Replace plug
Engine runs, but dies or does not accelerate properly	Air filter	Air filter dirty	Normal wear	Clean or replace
	Fuel filter	Fuel filter dirty	Contaminants/residues in fuel	Replace
	Fuel vent	Fuel vent plugged	Contaminants/residues in fuel	Clean or replace
	Spark Plug	Plug dirty/worn	Normal wear	Clean and adjust or replace
	Carburetor	Improper adjustment	Vibration	Adjust
	Cooling System	Cooling system dirty/plugged	Extended operation in dirty/dusty locations	Clean
	Spark Arrestor Screen	Spark arrestor screen plugged	Normal wear	Replace
Engine does not crank	N/A	N/A	Internal engine problem	See your Echo dealer



DANGER

Fuel vapors are **extremely** flammable and may cause fire and/or explosion. **Never** test for ignition spark by grounding spark plug near cylinder plug hole, otherwise serious personal injury may result.

STORAGE



WARNING

During operation the muffler or catalytic muffler and surrounding cover become hot. Always keep exhaust area clear of flammable debris during transportation or when storing, otherwise serious property damage or personal injury may result.

Long Term Storage (over 30 days)

Do not store your unit for a prolonged period of time (30 days or longer) without performing protective storage maintenance which includes the following:

1. Store unit in a dry, dust free place, out of the reach of children.



DANGER

Do not store in enclosure where fuel fumes may accumulate or reach an open flame or spark or serious personal injury may result.

2. Place the stop switch in the "OFF" position.
3. Remove accumulation of grease, oil, dirt and debris from exterior of unit.
4. Perform all periodic lubrication and services that are required.
5. Tighten all the screws and nuts.
6. **Drain** the fuel tank **completely** and pull the recoil starter handle several times to remove fuel from the carburetor.
7. Remove the spark plug and pour 7 cc (1/4 oz.) of fresh, clean, two-stroke engine oil into the cylinder through the spark plug hole.
 - A. Place a clean cloth over the spark plug hole.
 - B. Pull the recoil starter handle 2-3 times to distribute the oil inside the engine.
 - C. Observe the piston location through the spark plug hole. Pull the recoil starter handle slowly until the piston reaches the top of its travel and leave it there.
8. Install the spark plug (do not connect spark plug cable).
9. Install the guide bar cover on the guide bar and saw chain during storage.

IMPORTANT

Some tree sap and resins are corrosive. Thoroughly wash the guide bar and sprocket areas after each use, then coat metal parts with light oil.

SPECIFICATIONS

MODEL -----	PPT-265/H/S
Length (Standard) (PPT-265/H) -----	2.72 m (8 ft. 11 in.)
Length (Standard) (PPT-265S)-----	1.96 m (6 ft. 5 in.)
Length (Extended) (PPT-265/H)-----	3.71 m (12 ft. 2 in.)
Length (Extended) (PPT-265S) -----	2.41 m (7 ft. 11 in.)
Length w/extension (PPT-265/H)-----	4.93 m (16 ft. 2 in.)
Length w/extension (PPT-265S)-----	3.94 m (12 ft. 11 in.)
Width (PPT-265/H) -----	.25 m (9.8 in.)
Width (PPT-265S) -----	.25 m (9.8 in.)
Height (PPT-265/H) -----	.25 m (9.7 in.)
Height (PPT-265S/H)-----	.25 m (9.7 in.)
Weight (dry) (PPT-265) -----	8.4 kg (18.5 lb.)
Weight (dry) (PPT-265H)-----	8.2 kg (18.0 lb.)
Weight (dry) (PPT-265S) -----	7.5 kg (16.5 lb.)
Engine Type -----	Air cooled, two-stroke, single cylinder gasoline engine
Bore-----	34.0 mm (1.34 in.)
Stroke-----	28.0 mm (1.10 in.)
Displacement -----	25.4 cc (1.55 cu. in.)
Exhaust System -----	Spark arrestor - catalytic muffler / muffler
Carburetor-----	Zama with Purge
Ignition System -----	CDI (capacitor discharge ignition)
Spark Plug -----	NGK BPM-8Y Gap 0.65 mm (0.026 in.)
Fuel -----	Mixed (Gasoline and Two-stroke Oil)
Fuel/Oil Ratio -----	50 : 1 Power Blend X™ ISO-L-EGD (ISO/CD 13738) and J.A.S.O. M345- <u>FD</u> , two-stroke, air-cooled engine oil.
Gasoline-----	Use 89 Octane unleaded. Do not use fuel containing methyl alcohol, more than 10% ethyl alcohol or 15% MTBE. Do not use alternative fuels such as E-15 or E-85.
Oil-----	Power Blend X™ Premium Universal 2-Stroke Oil
Fuel Tank Capacity -----	0.50 lit. (16.9 US fl. oz.)
Starter System -----	Automatic Recoil Starter
Clutch-----	Centrifugal Type
Sprocket Type -----	6 tooth spur, 9.53 mm (3/8 in.) pitch
Power Transmission Shaft Assembly -----	Aluminum Extrusion
Gear Case Ratio-----	1.5:1
Oiling System -----	Automatic
Saw Chain Oil Capacity -----	225 ml (7.6 oz.)
Handle-----	Right hand grip w/throttle trigger and lockout
Shoulder Harness -----	Standard
Idle Speed (RPM)-----	2,850
Clutch Engagement Speed (RPM)-----	3,900
Wide Open Throttle Speed (RPM) -----	10,500 - 11,000
Guide Bar and Saw Chain (91)-----	305 mm (12 in.); 9.53 mm (3/8 in.) pitch, 0.050 gauge

WARRANTY STATEMENTS

ECHO LIMITED WARRANTY STATEMENT FOR PRODUCT SOLD IN USA AND CANADA BEGINNING 01/01/2010

ECHO'S RESPONSIBILITY

ECHO Incorporated's Limited Warranty, provides to the original purchaser that this ECHO product is free from defects in material and workmanship. Under normal use and maintenance from date of purchase, ECHO agrees to repair or replace at ECHO's discretion, any defective product free of charge at any authorized ECHO servicing dealer within listed below application time periods, limitations and exclusions. **THIS LIMITED WARRANTY IS ONLY APPLICABLE TO ECHO PRODUCTS SOLD BY AUTHORIZED ECHO DEALERS. IT IS EXTENDED TO THE ORIGINAL PURCHASER ONLY, AND IS NOT TRANSFERABLE TO SUBSEQUENT OWNERS EXCEPT FOR EMISSION RELATED PARTS.** Repair parts and accessories replaced under this warranty are warranted only for the balance of the original unit or accessory warranty period. Any damage caused by improper installation or improper maintenance is not covered by this warranty. All parts or products replaced under warranty become the property of ECHO, Inc. This warranty is separate from the Emission control warranty statement supplied with your new product. Please consult the Emission Control Warranty Statement for details regarding emission related parts. For a list of Authorized ECHO Dealers refer to WWW.ECHO-USA.COM or call 1-800-432-ECHO.

OWNER'S RESPONSIBILITY

To ensure trouble free warranty coverage it is important that you register your ECHO equipment on-line at WWW.ECHO-USA.COM or by filling out the warranty registration card supplied with your unit. Registering your product confirms your warranty coverage and provides a direct link if we find it necessary to contact you.

The owner shall demonstrate reasonable care and use, and follow preventative maintenance, storage, fuel and oil usage as prescribed in the operator's manual. Should a product difficulty occur, you must, at your expense, deliver or ship your ECHO unit to an authorized ECHO servicing dealer for warranty repairs (within the applicable warranty period), and arrange for pick-up or return of your unit after the repairs have been made. For your nearest authorized ECHO servicing dealer, call ECHO's Dealer Referral Center, at 1-800-432-ECHO or you can locate an ECHO servicing dealer at WWW.ECHO-USA.COM. Should you require assistance or have questions concerning ECHO's Warranty Statement, you can contact our Consumer Product Support Department at 1-800-673-1558 or contact us through the web at WWW.ECHO-USA.COM.

PRODUCT WARRANTY PERIOD

RESIDENTIAL APPLICATION

- **5 YEAR WARRANTY** - All units for residential, or non-income producing use will be covered by this limited warranty for **five (5) years** from date of purchase.

EXCEPTIONS:

- For two-stroke engine powered products, the electronic ignition module, flexible drive cables, SRM solid drive shafts, and TC tines are warranted for the **life*** of the product on parts only.
- Cutting attachments such as, but not limited to, bars, chains, sprockets, blades, and nylon trimmer heads for residential or non-income producing use will be covered for failures due to defects in material or workmanship for a period of **60 days** from original product purchase date. Any misuse from contact with concrete, rocks, or other structures is not covered by this warranty.
- ECHO's Rapid Loader String Head carries a lifetime warranty on the line locking system, parts only; no labor. Refer to your operator's manual for string head installation and maintenance instructions.
- All SB-Series and PRO ATTACHMENT SERIES Split Shaft attachments carry the same warranty duration as the units they are designed to fit.

COMMERCIAL APPLICATION

- **1 YEAR WARRANTY** - All Chain Saws, QuikVent Saws, and Cut-Off Saws for commercial, institutional, agricultural, industrial, or income producing use will be covered by this limited warranty for one **(1) year** from the date of purchase.
- **2 YEAR WARRANTY** - All other units for commercial, institutional, agricultural, industrial, or income producing use will be covered by this limited warranty for two **(2) years** from the date of purchase.

EXCEPTIONS:

- For two-stroke engine powered products, the electronic ignition module, flexible drive cables, SRM solid drive shafts and TC tines, are warranted for the **life*** of the product on parts only.
- Cutting attachments such as, but not limited to, bars, chains, sprockets, blades, and nylon trimmer heads for commercial, institutional, agricultural, industrial, rental, or income producing will be covered for failures due to defects in material or workmanship for a period of **30 days** from original product purchase date. Any misuse from contact with concrete, rocks, or other structures is not covered by this warranty.
- ECHO's Rapid Loader String Head carries a lifetime warranty on the line locking system, parts only; no labor. Refer to your operator's manual for string head installation and maintenance instructions.
- All SB-Series and PRO ATTACHMENT SERIES Split Shaft attachments carry the same warranty duration as the units they are designed to fit.

RENTAL APPLICATION - 90 DAYS WARRANTY

- Units for rental use will be covered against defects in material and workmanship for a period of 90 days from the date of purchase.

* ECHO's liability under the "Lifetime" coverage is limited to furnishing parts specified under the PRODUCT WARRANTY PERIOD section of this warranty statement for "**Life**" free of charge for a period of ten (10) years after the date of the complete unit's final production.

PURCHASED REPAIR PARTS, SHORT BLOCKS AND ACCESSORIES

- 90-day residential, or non-income producing warranty
- 30-day commercial, institutional, agricultural, industrial, income producing, or rental application warranty

ATTENTION TWO-STROKE ENGINE POWER PRODUCT OWNERS

This ECHO two-stroke engine power product is a quality-engineered unit which has been manufactured to exact tolerances to provide superior performance. To help ensure the performance of the unit, it is required to use two-stroke oil which meets the ISO-L-EGD Standard per ISO/CD 13738 and JASO M345/FC/FD Standards. **ECHO Power Blend™ Two-Stroke Oil** is a premium two-stroke oil specifically formulated to meet ISO-L-EGD (ISO/CD 13738) and JASO M345/FC/FD Standards. The use of two-stroke oils designed for other applications, such as for outboard motors or lawnmowers can result in severe engine damage, and will void your two-stroke engine limited warranty.

THIS WARRANTY DOES NOT COVER DAMAGE CAUSED BY:

- Lack of lubrication or engine failure, due to the use of two-stroke oils that do not meet the ISO-L-EGD (ISO/CD 13738) and JASO M345/FC/FD Standards. Engine problems due to inadequate lubrication caused by failure to use an ISO-L-EGD compliant and JASO M345/FC/FD registered oil, will void the two-stroke engine limited warranty. **ECHO Power Blend™ Two-Stroke Oil** meets the ISO-L-EGD and JASO M345/FC/FD Standard. Emission related parts are covered for 5 years residential use or 2 years commercial use regardless of two-stroke oil used, per the statement listed in the EPA or California Emission Defect Warranty Explanation.
- Damage caused by use of gasohol, containing methanol (wood alcohol), or gasoline containing less than 89 octane. Only use gasoline which contains 89 octane or higher. Gasohol which contains a **maximum** 10% ethanol (grain alcohol) or 15% MTBE (methyl/tertiary/butyl/ether) is also approved. The prescribed mixing ratio of gasoline to oil is listed on the ECHO oil label and covered in your operator's manual.
- Engine damage caused by use of ether or any starting fluids.
- Damage caused by tampering with engine speed governor or emission components, or running engines above specified and recommended engine speeds as listed in your operator's manual.
- Operation of the unit with improperly maintained/removed cutting shield or removed/damaged air filter.
- Damage caused by dirt, pressure or steam cleaning the unit, salt water, corrosion, rust, varnish, abrasives, and moisture.
- Defects, malfunctions or failures resulting from abuse, misuse, neglect, modifications, alterations, normal wear, improper servicing, or use of unauthorized attachments.
- Incorrect storage procedures, stale fuel, including failure to provide or perform required maintenance services as prescribed in the operator's manual. Preventative maintenance as outlined in the operators manual is the customer's responsibility.
- Failures due to improper set-up, pre-delivery service or repair service by anyone other than authorized ECHO servicing dealer during the warranty period.
- Certain parts and other items are not warranted, including but not limited to: lubricants, starter cords, and engine tune-ups.
- Use of spark plugs other than those meeting performance and durability requirements of the OEM spark plug listed in the Operator's Manuals.
- Overheating or carbon scoring failures due to restricted, clogged exhaust port or combustion chamber, including damage to spark arrester screen.
- Adjustments after the first (30) thirty days and beyond, such as carburetor adjustment and throttle cable adjustment.
- Damage to gears or gear cases caused by contaminated grease or oil, use of incorrect type or viscosity of lubricants, and/or failure to comply with recommended grease or oil change intervals.
- Damage caused by loading SHRED 'N' VAC® beyond recommended capacity.
- Damage caused by pump or sprayer running dry, pumping or spraying caustic or flammable materials, or lack of or broken strainers.
- Additional damage to parts or components due to continued use after operational problem or failure occurs. Should operational problem or failure occur, the product should not be used, but delivered as is to an authorized ECHO servicing dealer.

It is a dealer's and/or customer's responsibility to complete and return the warranty registration card supplied with your ECHO product or by visiting WWW.ECHO-USA.COM. Your receipt of purchase including date, model and serial number must be maintained and presented to an authorized ECHO servicing dealer for warranty service. Proof of purchase rests solely with the customer. Some states do not allow limitations on how long an implied warranty lasts, so the above limitations may not apply to you. Some states do not allow the exclusion or limitation of incidental or consequential damages, so you may also have other specific legal rights which vary from state to state. This limited warranty is given by ECHO Incorporated, 400 Oakwood Rd., Lake Zurich, IL 60047.

DISCLAIMER OF IMPLIED WARRANTIES

This limited warranty is in lieu of all other expressed or implied warranties, including any warranty of FITNESS FOR A PARTICULAR PURPOSE OR USE and any implied warranty of **MERCHANTABILITY** otherwise applicable to this product. ECHO and its affiliated companies shall not be liable for any special incidental or consequential damage, including lost profits. There are no warranties extended other than as provided herein. This limited warranty may be modified only by ECHO.

ECHO INCORPORATED EMISSION CONTROL WARRANTY STATEMENT FOR ECHO AND SHINDAIWA BRANDS

The Environmental Protection Agency (EPA) and the California Air Resources Board (C.A.R.B.) and ECHO Incorporated (ECHO Inc.) are pleased to explain the emission control system warranty on your 2010 and later equipment/small off-road engine (SORE). New equipment/SORE must be designed, built and equipped to meet stringent EPA and C.A.R.B. anti-smog standards. ECHO Inc. must warrant the emission control system on your equipment/SORE for the periods of time listed below, provided there has been no abuse, neglect or improper maintenance of your equipment/SORE. Your emission control system may include parts such as: carburetor, fuel-injection system, ignition system, catalytic converter/muffler, fuel tank, fuel feed lines, fuel cap assembly, spark plug, air filters, and other associated components. Where a warrantable condition exists, ECHO Inc will repair your equipment/SORE at no cost to you including diagnosis, parts and labor. The Emission Control System warranty is extended to the original owner including all subsequent owners.

MANUFACTURER'S WARRANTY COVERAGE:

The emission control system is warranted for 2 years or the length of the ECHO Inc. warranty, whichever is longer. If any emission-related part on your equipment is defective, the part will be repaired or replaced by ECHO Inc. or its Authorized Service Representative.

OWNER'S WARRANTY RESPONSIBILITIES:

As the equipment/SORE owner, you are responsible for the performance of the required maintenance listed in your Operator's Manual. ECHO Inc. recommends that you retain all receipts covering maintenance on your equipment/SORE however, ECHO Inc. cannot deny warranty solely for the lack of receipts or for your failure to ensure the performance of all scheduled maintenance. As the equipment/SORE owner, you should be aware that ECHO Inc. may deny you warranty coverage if your equipment/SORE or a part has failed due to abuse, neglect, improper maintenance or unapproved modifications.

You are responsible for presenting your equipment/SORE to an ECHO Inc. authorized service representative as soon as a problem exists. The warranty repairs should be completed in a reasonable amount of time, not to exceed 30 days. If a warrantable condition exists and there is no Authorized Dealer within 100 miles, ECHO Inc. will pay to ship the unit to the nearest authorized dealer. If you have questions regarding your warranty coverage, you should contact ECHO Inc. at 1-800-673-1558, web site WWW.ECHO-USA.COM or contact Shindaiwa at 1-877-986-7783, web site WWW.SHINDAIWA.COM.

WHAT DOES THIS WARRANTY COVER?

ECHO Inc. warrants that your equipment/SORE was designed, built and equipped to conform with applicable EPA and C.A.R.B. emissions standards and that your equipment/SORE is free from defects in material and workmanship that would cause it to fail to conform with applicable requirements for 2 years or the length of the ECHO Inc. warranty, whichever is longer. The warranty period begins on the date the product is purchased by an end user.

HOW WILL A COVERED PART BE CORRECTED?

If there is a defect in a part covered by this warranty, any ECHO Inc. Authorized Service Dealer will correct the defect. You will not have to pay anything to have the part adjusted, repaired or replaced. This includes any labor and diagnosis for warranted repairs performed by the dealer. In addition, engine parts not expressly covered under this warranty but whose failure is a result of a failure of a covered part will be warranted.

WHAT PARTS ARE COVERED?

Any applicable emission related part not scheduled for "required maintenance" will be repaired or replaced within the warranty period. The repaired or replaced part will be warranted for the remaining ECHO Inc. warranty period.

Any warranted part that is scheduled only for regular inspection in the written instructions supplied is warranted for the warranty period stated above. Any such part repaired or replaced under warranty will be warranted for the remaining ECHO Inc. warranty period.

Any emission related part scheduled for replacement during "required maintenance" is warranted for the period of time prior to the first scheduled replacement point for that part. Any such part repaired or replaced under warranty shall be warranted for the remainder of the period prior to the first scheduled replacement point for that part.

Any manufacturer-approved replacement part may be used in the performance of any warranty maintenance or repairs on emission related parts, and must be provided without charge if the part is still under warranty.

Any replacement part that is equivalent in performance and durability may be used in non-warranty maintenance or repairs, and shall not reduce the warranty obligations of the manufacturer.

Throughout the equipment/SORE warranty period, ECHO Inc. will maintain a supply of warranted parts sufficient to meet the expected demand for such parts.

SPECIFIC EMISSION RELATED WARRANTED PARTS:

- Electronic Ignition System
- Catalytic Converter / Muffler Assembly
- Choke
- Fuel Tank
- Air Filter
- Spark Plug
- Carburetor (complete assembly or replaceable components)
- Fuel-Injection Assembly (or replaceable components)
- Fuel Cap Assembly
- Fuel Feed Line (and associated clamps/connectors as applicable)

WHAT IS NOT COVERED?

Any failure caused by abuse, neglect, improper maintenance, unapproved modifications, use of unapproved add-on parts/modified parts or unapproved accessories.

This Emission Control Warranty is valid only for the U.S.A., it's Territories, and Canada.

99922201033
01/2010

NOTES

SERVICING INFORMATION

PARTS/SERIAL NUMBER

Genuine ECHO Parts and ECHO REPOWER™ Parts and Assemblies for your ECHO products are available only from an Authorized ECHO Dealer. When you do need to buy parts **always** have the Model Number, Type and Serial Number of the unit with you. You can find these numbers on the engine housing. For future reference, write them in the space provided below.

Model No. _____ SN. _____

SERVICE

Service of this product during the warranty period must be performed by an Authorized ECHO Service Dealer. For the name and address of the Authorized ECHO Service Dealer nearest you, ask your retailer or call: 1-800-432-ECHO (3246). Dealer information is also available on our Web Site. When presenting your unit for Warranty service/repairs, proof of purchase is required.

ECHO CONSUMER PRODUCT SUPPORT

If you require assistance or have questions concerning the application, operation or maintenance of this product you may call the ECHO Consumer Product Support Department at 1-800-673-1558 from 8:30 am to 4:30 pm (Central Standard Time) Monday through Friday. Before calling, please know the model and serial number of your unit.

WARRANTY REGISTRATION

To ensure trouble free warranty coverage it is important that you register your ECHO equipment on-line at www.echo-usa.com or by filling out the warranty registration card supplied with your unit. Registering your product confirms your warranty coverage and provides a direct link between you and ECHO if we find it necessary to contact you.

ADDITIONAL OR REPLACEMENT MANUALS

Replacement Operator, Safety Manuals, and Parts Catalogs are available from your ECHO dealer or at www.echo-usa.com or by contacting ECHO Inc., 400 Oakwood Road, Lake Zurich, IL 60047 (800-673-1558). Always check the ECHO Web Site for updated information.

Safety Videos are available from your Echo dealer. A \$5.00 shipping charge will be required for each video.

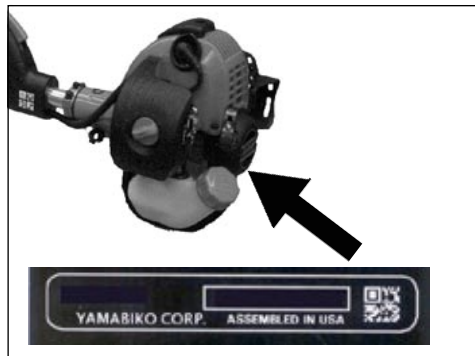

DEALER?

Call
1-800-432-ECHO
1-800-432-3246
or
www.echo-usa.com

CONSUMER PRODUCT SUPPORT

1-800-673-1558
8:30 - 4:30 Mon - Fri C.S.T.



ECHO
ECHO, INCORPORATED®

400 OAKWOOD ROAD
LAKE ZURICH, IL 60047

www.echo-usa.com

E07811001001/E07811999999
E09912001001/E09912999999

(S) E07111001001/E07111999999
(S) E09412001001/E09412999999
(H) E06711001001/E06711999999
(H) E06812001001/E06812999999